

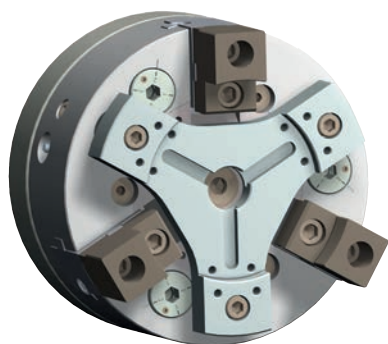

Special applications

Special applications - rational clamping solutions



KFD-N draw-down chuck

APPLICATION

Power chucks based on KFD principle with draw-down for clamping tasks for external clamping where workpiece axial run-out errors have to be minimized.

TYPE AND FUNCTION

Retractable chuck body for drawing down the workpiece onto a rigid plane face. Built-in pressure springs put the body back into its original position.

CUSTOMER BENEFITS

- ③ High clamping precision and clamping force by means of the KFD principle
- ③ With active pull-down for maximum plane-parallelism

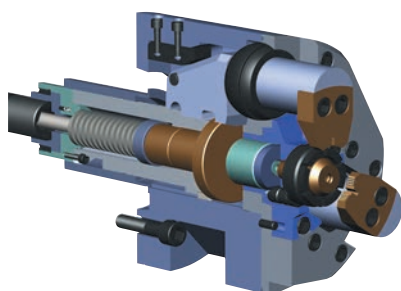

KKHFR combination chuck

APPLICATION

Optimally suited for the complete machining of workpieces, such as crankshafts and cam shafts.

TYPE AND FUNCTION

With retractable clamping jaws and face driver. The clamping jaws are retracted for finish turning; the workpiece is moved by the face driver. This way, the outer diameter can be completely machined. For the force-actuated face driver with a rigid point, the chuck is actuated via the hydraulic double piston cylinder and, in the case of a face driver with spring-loaded point, via the hydraulic clamping cylinder with enlarged stroke.

CUSTOMER BENEFITS

- ③ Efficient complete machining of shafts in one set-up



KTF indexing chuck

APPLICATION

For rationally turning of workpieces with a centric and an eccentric center of rotation (or several eccentric centers of rotation), such as crankshafts, housings or pistons.

TYPE AND FUNCTION

Force-actuated. Clamping and indexing via rotary piston cylinders with 4-way oil distributor in connection with Cardan linkage assembly. Indexing angle 180°. Eccentric dimension constant or adjustable.

CUSTOMER BENEFITS

- ③ Efficient machining of workpieces by shifting the center to be machined without reclamping

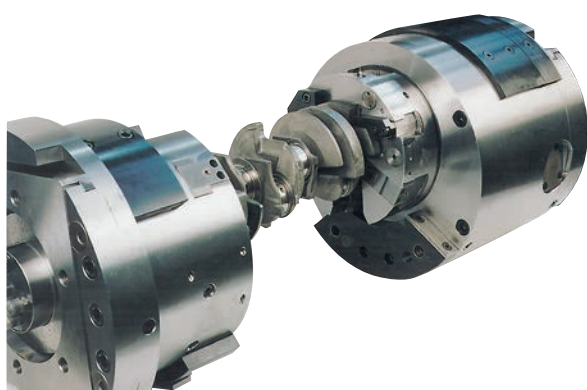

HTF indexing chuck

APPLICATION

Optimally suited for rationally turning workpieces with a centric and an eccentric center of rotation (or several eccentric centers of rotation), such as crankshafts, housings or pistons.

TYPE AND FUNCTION

Hydraulically operated. Indexing is done using 2 hydraulically actuated racks. Clamping by means of integrated hydraulic pistons. Indexing angles 180°, 4x90°, 5x72°, 6x60°.

CUSTOMER BENEFITS

- ③ Efficient machining of workpieces by shifting the center to be machined without reclamping



Special applications - rational clamping solutions



HSF indexing chuck

APPLICATION

For machining workpieces with crossing axes.

TYPE AND FUNCTION

Hydraulically actuated indexing chuck. The swivel axes lie perpendicular to the rotational axis. Oil distributor or clamping cylinder required for actuation. Equipped with a moving clamping jaw and a swivelable console jaw. The console jaws define the height of the clamping position of the inserted workpiece.

CUSTOMER BENEFITS

- ⌚ Rational machining in one set-up
- ⌚ Fully automated work sequence of swivel positions while the machine is running
- ⌚ High workpiece precision with regard to the crossing axes, since there is no reclamping
- ⌚ Long service life thanks to sturdy construction



KSFZ indexing chuck

APPLICATION

For workpieces, such as forgings and castings, where a large diameter tolerance is to be compensated during clamping.

TYPE AND FUNCTION

Force-actuated indexing chuck.

CUSTOMER BENEFITS

- ⌚ Centrally clamping - raw part tolerances are compensated
- ⌚ Maximum productivity thanks to rational machining option in one set-up
- ⌚ High workpiece precision, since no reclamping

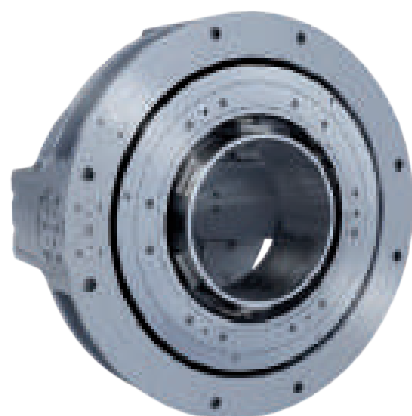

HSFZ ring indexing chuck

APPLICATION

Optimally suited for machining couplings from 2-3/8" to 20".

TYPE AND FUNCTION

Hydraulically actuated ring indexing chuck. 3-jaws centrally and 3-jaws compensating clamping.

CUSTOMER BENEFITS

- ⌚ No deformation of the workpiece thanks to clamping inserts with several clamping points
- ⌚ Maximum productivity thanks to rational machining option in one set-up
- ⌚ High repeat positioning accuracy for maximum precision requirements



Technical data

Quick-action clamping device change system

For quickly changing the clamping device

- ⊕ Easy clamping device change taking all the safety features of modern clamping technology into account
- ⊕ Use of nearly any clamping mandrels, face drivers or power chucks - they must only have the same connections - on the basic adapter, with shortest time required

Construction:

Similar to the automatic / semi-automatic clamping device change system, on the manual change system, too, an increasing number of variants can be produced in decreasing batch sizes more cost-effectively. A standard clamping cylinder without additional devices is sufficient for quickly changing the clamping device.

Particularly clamping mandrels, which often require a change in the clamping mandrel size due to its design, but also clamping systems such as face drivers or power chucks, can be quickly and safely interchanged among each other.

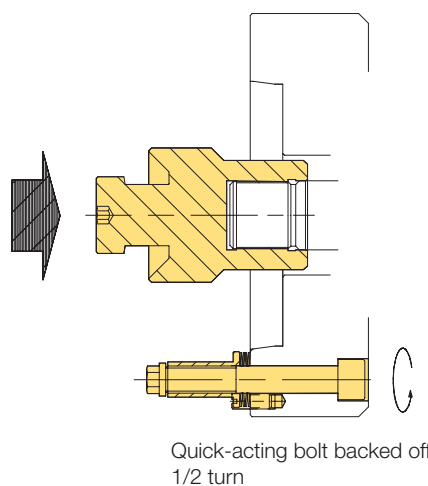
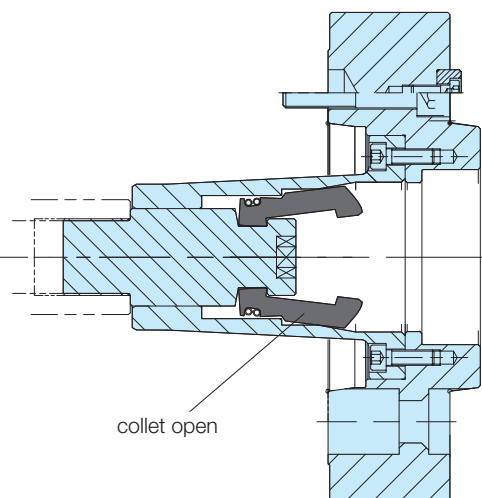
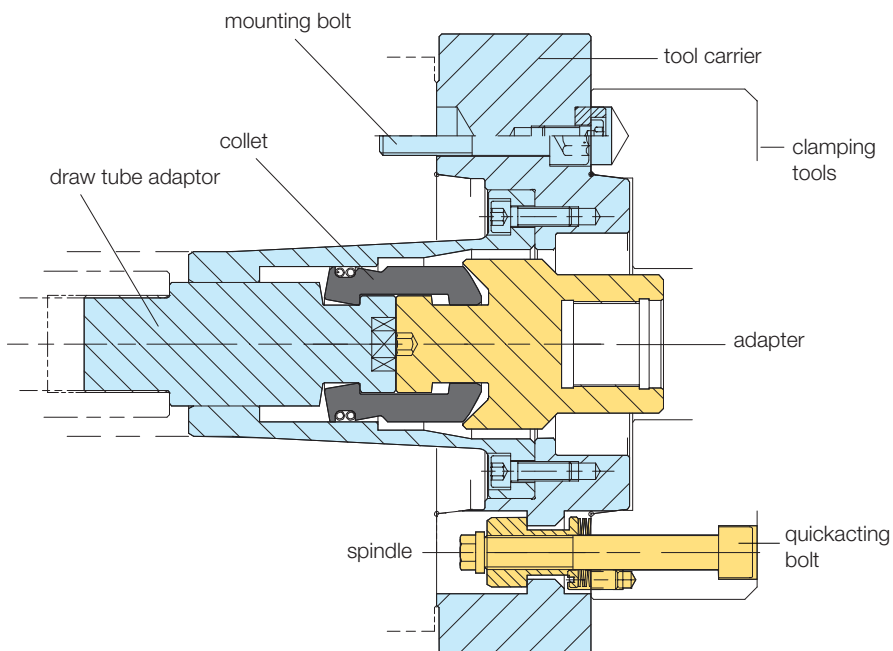

Changing the clamping device:

- ⊕ Move clamping cylinder to the front position
- ⊕ Loosen the quick-action clamping screw by 1/2 turn
- ⊕ Lift up the clamping device



Technical data

Quick-action clamping device change system

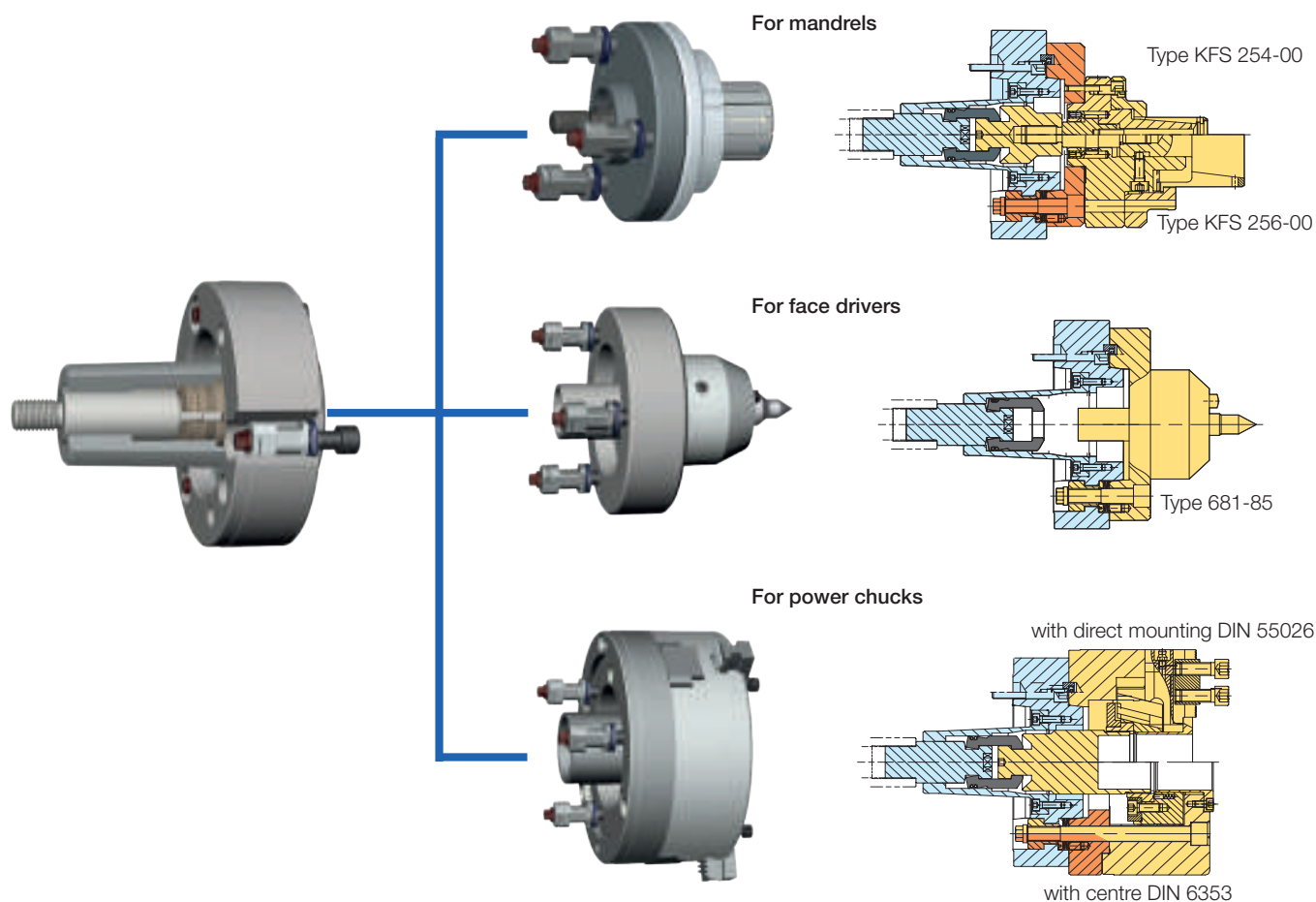

Technical features:

- ⊕ Exact take-up and positioning of the clamping device using short taper mount
- ⊕ Change precision within 0.005 mm
- ⊕ Change time approx. 30 seconds
- ⊕ Easy handling of the change operation
- ⊕ Locking the clamping device with 3 bayonet nuts and a collet chuck as intermediate piece for draw connection
- ⊕ Rotary lock of bayonet nut
- ⊕ High clamping precision
- ⊕ Clamping cylinders without additional devices
- ⊕ Stroke control on clamping cylinder
- ⊕ Central lubrication and/or air sensing possible
- ⊕ The manual quick-action clamping device change systems RMS, in combination with the RÖHM safety cylinders SZS, OVS, LHS-L, LVS, EHS and EVS, meet the guidelines of the Employer's Liability Insurance Association

Function:

A basic adapter is fastened to a turning spindle, in which a collet chuck is integrated for force transfer. The actual clamping device is adjusted on this basic adapter with quick-action clamping screws by a half turn of the wrench and then tightened. The collet chuck and clamping device are actuated via a safety clamping cylinder mounted to the end of the spindle without additional devices.

Function description:

The basic adapter with built-in collet chuck and draw piece with draw tube connection is screwed onto the spindle with 3 fastening screws. Through the positioning of the adapter of the respective clamping device (e.g. clamping mandrel, face driver, power chuck), the collet chuck is closed, thereby establishing the connection between the draw bar and actuating element (e.g. piston). The clamping device is fastened manually via 3 quick-action clamping screws by turning the wrench 1/2 turn each. The rotary lock of the bayonet nut is secured by a cylinder pin system. This guarantees equivalent fastening as compared to conventional fastening types. The clamping device is dismantled in the opposite order.